



JLE05BRS5-2

1-Line Bi-directional TVS Diode

Jialan-Microelectronics

Description

The JLE05BRS5-2 is a bi-directional TVS diode, utilizing leading monolithic silicon technology to provide fast response time and low ESD clamping voltage, making this device an ideal solution for protecting voltage sensitive high-speed data lines. The JLE05BRS5-2 has an ultra-low capacitance with a typical value at 0.4pF, and complies with the IEC 61000-4-2 (ESD) standard with $\pm 20\text{kV}$ air and $\pm 15\text{kV}$ contact discharge. The small size, ultra-low capacitance and high ESD surge protection make JLE05BRS5-2 an ideal choice to protect cell phone, digital video interfaces and other high speed ports.

Features

- * Ultra low capacitance: 0.4pF typical
- * Ultra low leakage: nA level
- * Operating voltage: 5V
- * Low clamping voltage
- * 2-pin leadless package
- * Complies with following standards:
 - IEC 61000-4-2 (ESD) immunity test
 - Air discharge: $\pm 20\text{kV}$
 - Contact discharge: $\pm 15\text{kV}$
 - IEC61000-4-5 (Lightning) 4A (8/20 μs)
- * RoHS Compliant
- * Package:SOD-523

Circuit Diagram

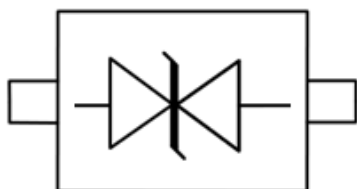

Circuit Diagram

Applications

- * Smart phones
- * Display Ports
- * MDDI Ports
- * USB Ports
- * Digital Video Interface (DVI)
- * PCI Express and Serial SATA Ports

Marking Diagram

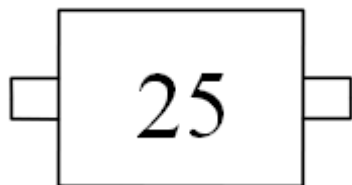

Transparent top view

25:Device Marking Code

Ordering Information

Part Number	Packaging	Reel Size
JLE05BRS5-2	10000/Tape & Reel	7 inch



JLE05BRS5-2

Absolute Maximum Ratings ($T_A=25^\circ\text{C}$ unless otherwise specified)

Parameter	Symbol	Value	Unit
Peak Pulse Power (8/20 μs)	Ppk	80	W
Peak Pulse Current (8/20 μs)	IPP	4	A
ESD per IEC 61000-4-2 (Air)	VESD	± 20	kV
ESD per IEC 61000-4-2 (Contact)		± 15	
Operating Temperature Range	TJ	-55 to +125	$^\circ\text{C}$
Storage Temperature Range	Tstg	-55 to +150	$^\circ\text{C}$

Electrical Characteristics ($T_A=25^\circ\text{C}$ unless otherwise specified)

Parameter	Symbol	Test Condition	Min	Typ	Max	Unit
Reverse Working Voltage	V_{RWM}				5.0	V
Breakdown Voltage	V_{BR}	$I_T = 1\text{mA}$	6.5		9.5	V
Reverse Leakage Current	I_R	$V_{RWM} = 5.0\text{V}$			0.5	μA
Clamping Voltage	V_C	$I_{PP} = 1\text{A}$ (8 x 20 μs pulse)			12	V
Clamping Voltage	V_C	$I_{PP} = 4\text{A}$ (8 x 20 μs pulse)			20	V
Junction Capacitance	C_J	$V_R = 0\text{V}$, $f = 1\text{MHz}$		0.3	0.5	pF

Portion Electronics Parameter

Symbol	Parameter
I_T	Test Current
I_{PP}	Maximum Reverse Peak Pulse Current
V_C	Clamping Voltage @ I_C

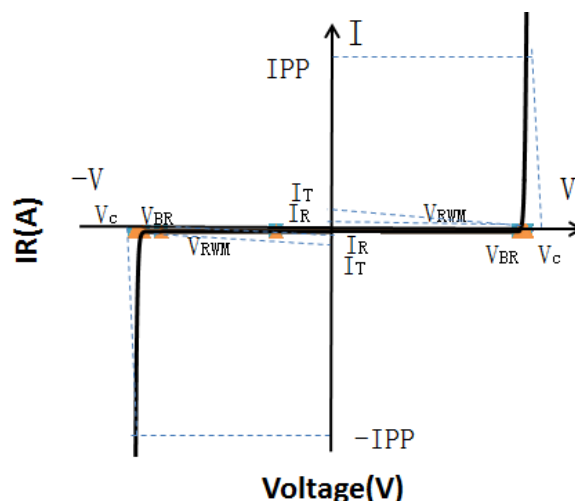



JLE05BRS5-2

Typical Performance Characteristics ($T_A=25^\circ\text{C}$ unless otherwise Specified)

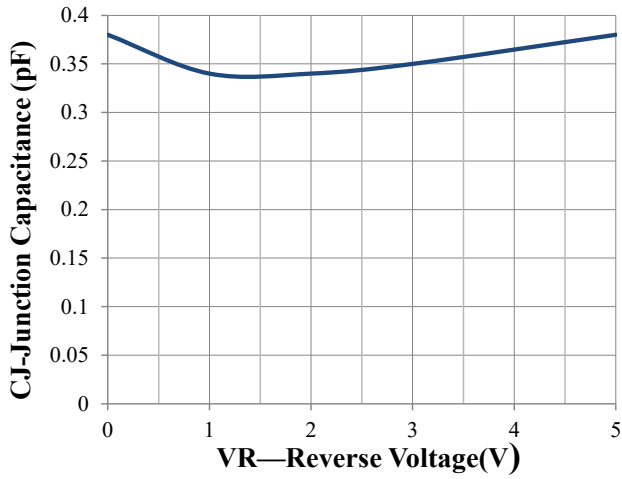

Junction Capacitance vs. Reverse Voltage

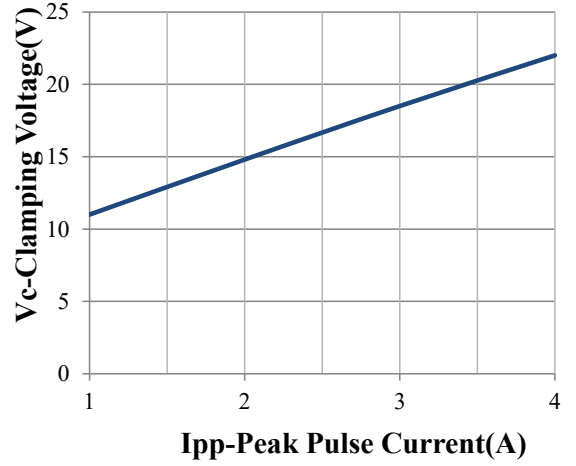

Clamping Voltage vs. Peak Pulse Current

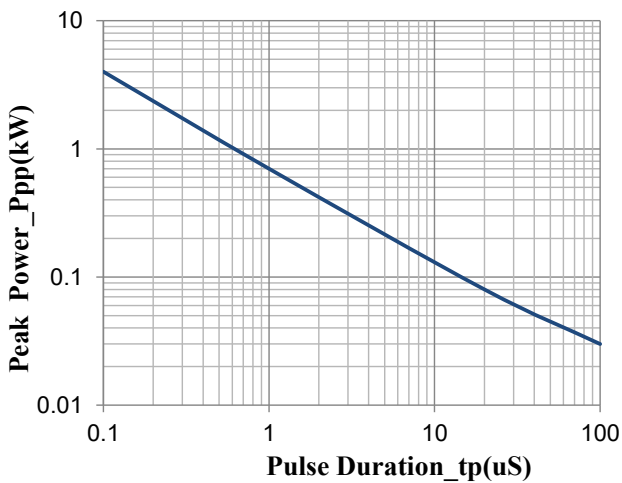

Peak Pulse Power vs. Pulse Time

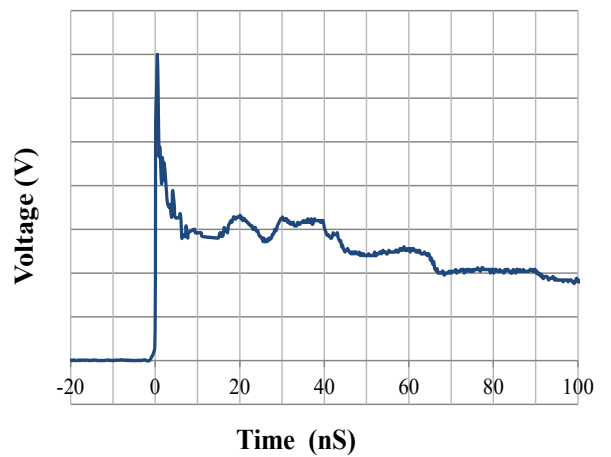

IEC61000-4-2 Pulse Waveform

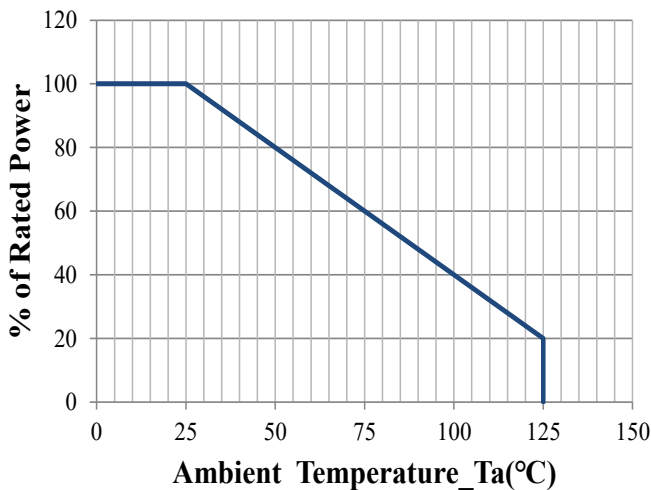

Power Derating Curve

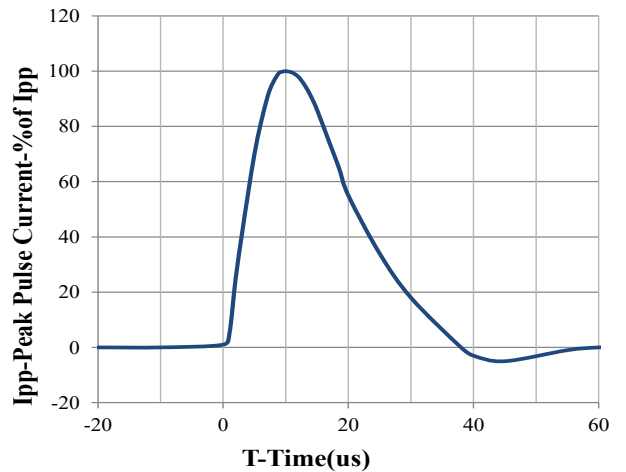

8 X 20us Pulse Waveform



JLE05BRS5-2

SOD-523 Package Outline Drawing

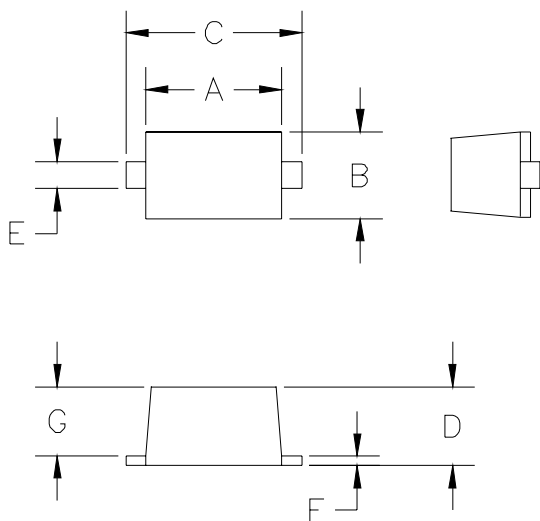

DIMENSIONS					
DIM ^N	INCHES		MM [1]		NOTE
	MIN	MAX	MIN	MAX	
A	.043	.051	1.10	1.30	—
B	.028	.035	0.70	0.90	—
C	.059	.067	1.50	1.70	—
D	.020	.028	0.50	0.70	—
E	.010	.014	0.25	0.35	—
F	.004	.008	0.10	0.20	—
G	.020	.028	0.50	0.70	—

[1] CONTROLLING DIMENSION: MILLIMETERS

Suggested Land Pattern

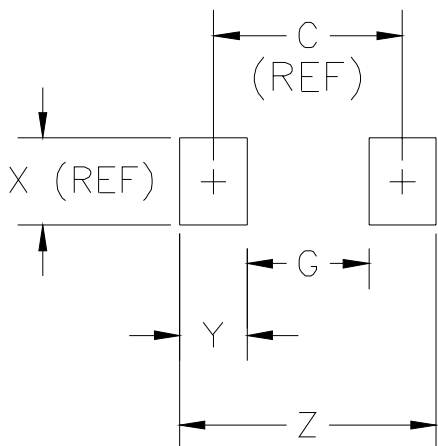

DIMENSIONS					
DIM ^N	INCHES		MM [1]		NOTE
	MIN	MAX	MIN	MAX	
C	—	.067	—	1.70	REF
G	—	.043	—	1.10	—
X	—	.031	—	0.80	REF
Y	—	.024	—	0.60	—
Z	—	.091	—	2.30	—

[1] CONTROLLING DIMENSION: MILLIMETERS

NOTICE

Jelan-Link reserves the right to make changes without further notice to any products here in.

Only obligations are those in the Jelan-Link Standard Terms and Conditions of Sale and in no case will Jelan-Link be liable for any incidental, indirect, or consequential damages arising from the sale, resale, use, or misuse of its products.