



Description

The JLS45UGD6-2L is an uni-directional TVS diode, utilizing leading monolithic silicon technology to provide fast response time and low ESD clamping voltage, making this device an ideal solution for protecting voltage sensitive data and power line. The JLS45UGD6-2L complies with the IEC 61000-4-2 (ESD) standard with $\pm 30\text{kV}$ air and $\pm 30\text{kV}$ contact discharge. It is assembled into an ultra-small 1.6x1.0x0.5mm lead-free DFN package. The small size and high ESD surge protection make JLS45UGD6-2L an ideal choice to protect cell phone, digital cameras, audio players and many other portable applications.

Features

- * 1400W peak pulse power (8/20 μs)
- * Low leakage: μA level
- * Operating voltage: 4.5V
- * Low clamping voltage
- * One power line protects
- * Complies with following standards:
 - IEC 61000-4-2 (ESD) immunity test
 - Air discharge: $\pm 30\text{kV}$
 - Contact discharge: $\pm 30\text{kV}$
 - IEC61000-4-5 (Lightning) 80A (8/20 μs)
- * RoHS Compliant
- * Package: DFN1610-2

Circuit Diagram

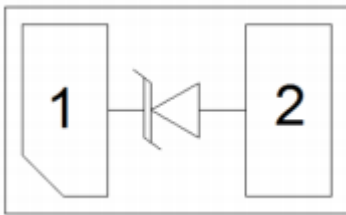

Circuit and Pin Schematic

Applications

- * Mobile Phones
- * Battery Protection
- * Power Line Protection
- * Vbat pin for Mobile Devices
- * Hand Held Portable Applications

Marking Diagram

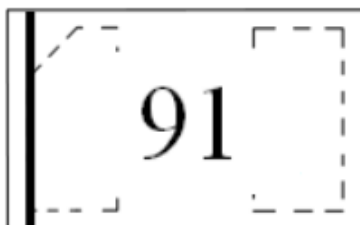

Transparent top view

91: Device Marking Code

Ordering Information

Part Number	Packaging	Reel Size
JLS45UGD6-2L	3000/Tape & Reel	7 inch



JLS45UGD6-2L

Absolute Maximum Ratings ($T_A=25^\circ\text{C}$ unless otherwise specified)

Parameter	Symbol	Value	Unit
Peak Pulse Power (8/20 μs)	Ppk	1400	W
Peak Pulse Current (8/20 μs)	IPP	80	A
ESD per IEC 61000-4-2 (Air)	VESD	± 30	kV
ESD per IEC 61000-4-2 (Contact)		± 30	
Operating Temperature Range	TJ	-55to +125	$^\circ\text{C}$
Storage Temperature Range	Tstg	-55 to +150	$^\circ\text{C}$

Electrical Characteristics ($T_A=25^\circ\text{C}$ unless otherwise specified)

Parameter	Symbol	Test Condition	Min	Typ	Max	Unit
Reverse Working Voltage	V_{RWM}				4.5	V
Breakdown Voltage	V_{BR}	$I_T = 1\text{mA}$	4.8	5.5		V
Reverse Leakage Current	I_R	$V_{RWM} = 4.5\text{V}$			10	μA
Clamping Voltage	V_C	$I_{PP} = 10\text{A}$ (8 x 20 μs pulse)			7.5	V
Clamping Voltage	V_C	$I_{PP} = 80\text{A}$ (8 x 20 μs pulse)			17	V
Junction Capacitance	C_J	$V_R = 0\text{V}$, $f = 1\text{MHz}$		470		pF

Portion Electronics Parameter

Symbol	Parameter
I_T	Test Current
I_{PP}	Maximum Reverse Peak Pulse Current
V_C	Clamping Voltage @ I_C

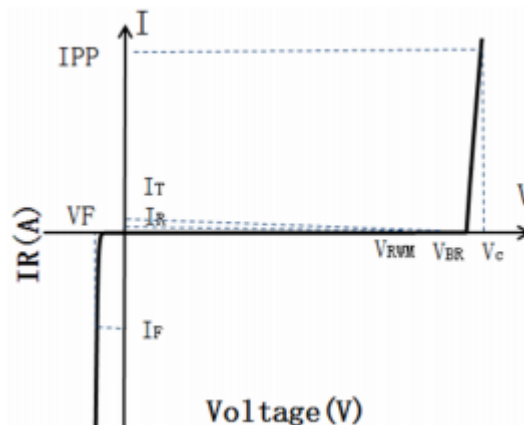



JLS45UGD6-2L

Typical Performance Characteristics ($T_A=25^\circ\text{C}$ unless otherwise Specified)

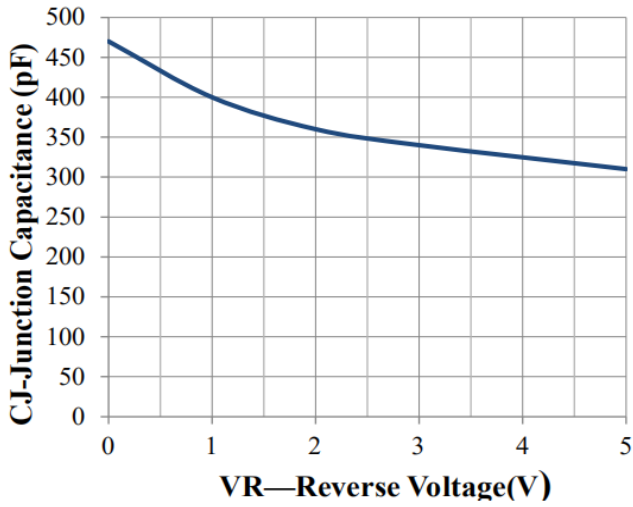

Junction Capacitance vs. Reverse Voltage

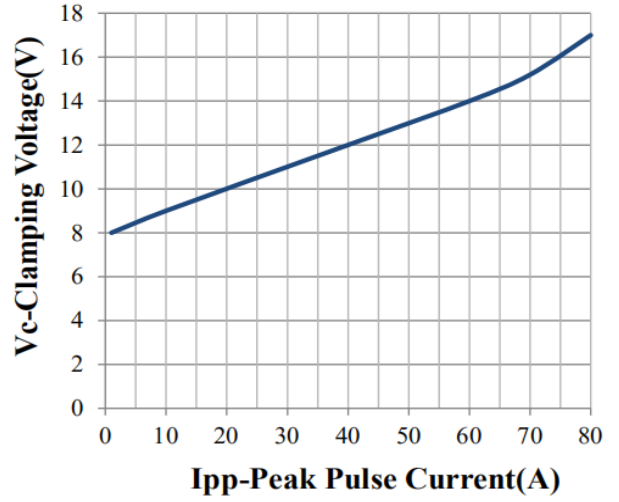

Clamping Voltage vs. Peak Pulse Current

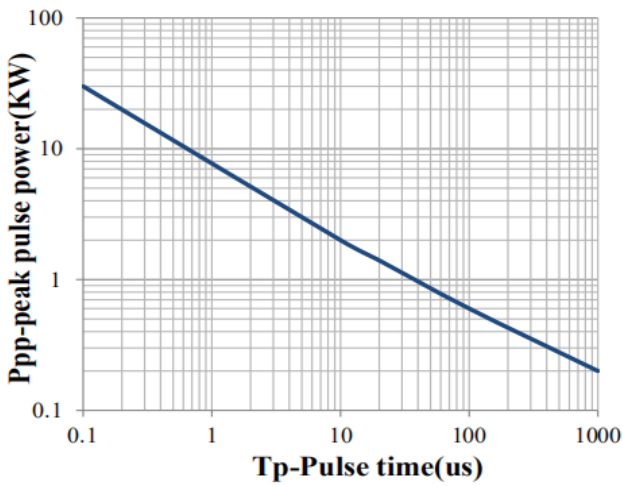

Peak Pulse Power vs. Pulse Time

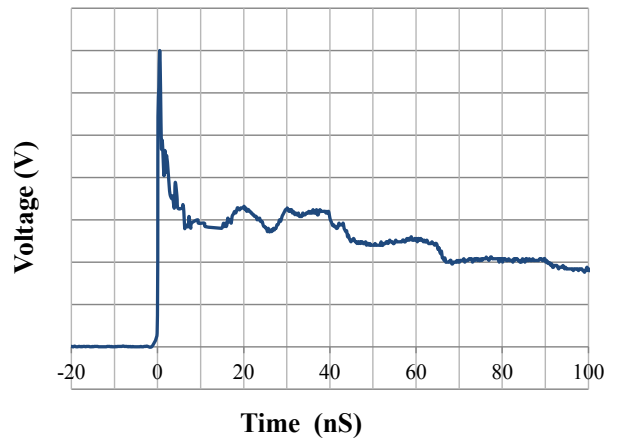

IEC61000-4-2 Pulse Waveform

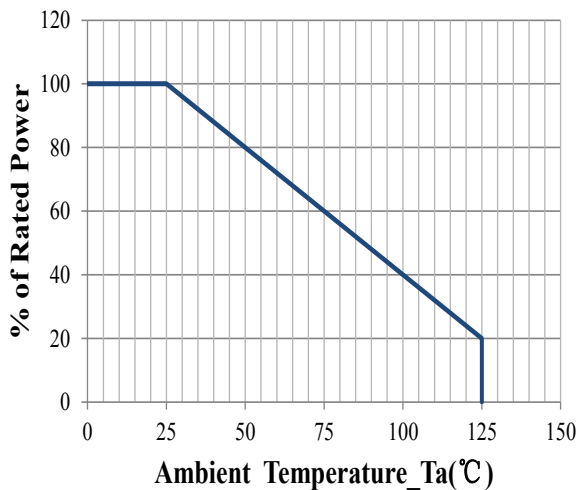

Power Derating Curve

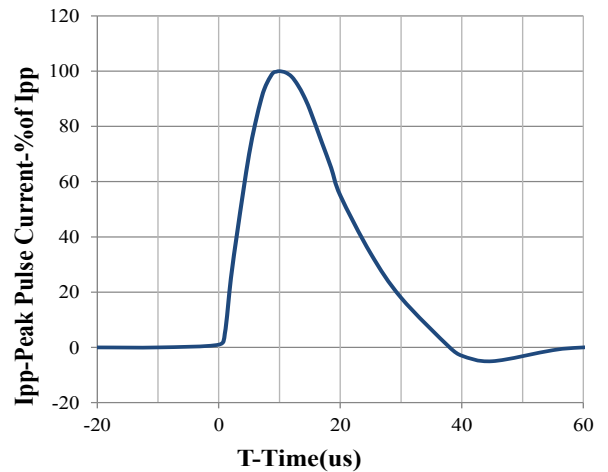

8 X 20us Pulse Waveform



JLS45UGD6-2L

DFN1610-2 Package Outline Drawing (Dimensions in millimeters)

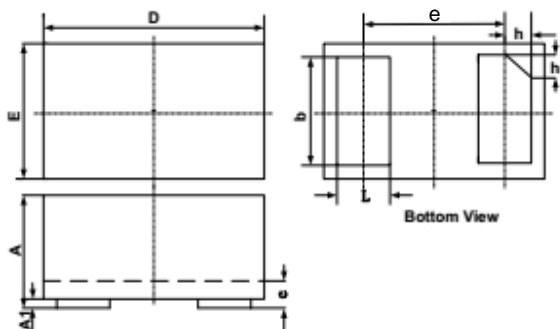

SYM	DIMENSIONS					
	MILLIMETERS			INCHES		
	MIN	NOM	MAX	MIN	NOM	MAX
A	0.45	0.50	0.55	0.018	0.020	0.022
A1	0.00	0.02	0.05	0.000	0.001	0.002
b	0.75	0.80	0.85	0.030	0.032	0.034
c	0.10	0.15	0.20	0.004	0.006	0.008
D	1.55	1.60	1.65	0.062	0.064	0.066
e	1.10 BSC			0.044 BSC		
E	0.95	1.00	1.05	0.038	0.040	0.042
L	0.35	0.40	0.45	0.014	0.016	0.018
h	0.15	0.20	0.25	0.006	0.008	0.010

Suggested Land Pattern

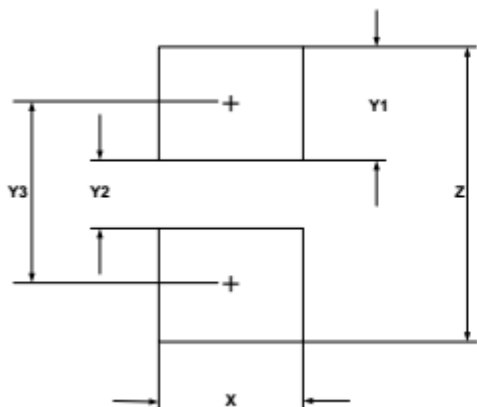

SYM	DIMENSIONS	
	MILLIMETERS	INCHES
X	1.00	0.040
Y1	0.62	0.025
Y2	0.60	0.024
Y3	1.22	0.049
Z	1.85	0.074

NOTICE

Jelan-Link reserves the right to make changes without further notice to any products here in.

Only obligations are those in the Jelan-Link Standard Terms and Conditions of Sale and in no case will Jelan-Link be liable for any incidental, indirect, or consequential damages arising from the sale, resale, use, or misuse of its products.