

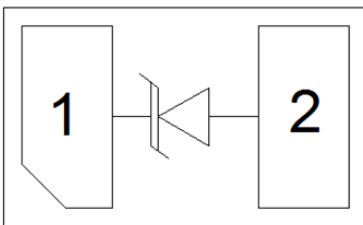

## Description

The JLS05UGD2-2 is a uni-directional TVS diode, utilizing leading monolithic silicon technology to provide fast response time and low ESD clamping voltage, making this device an ideal solution for protecting voltage sensitive data and power line. The JLS05UGD2-2 complies with the IEC 61000-4-2 (ESD) standard with  $\pm 30\text{kV}$  air and  $\pm 30\text{kV}$  contact discharge. It is assembled into an ultra-small 1.0x0.6x0.5mm lead-free DFN package. The small size and high ESD surge protection make JLS05UGD2-2 an ideal choice to protect cell phone, digital cameras, audio players and many other portable applications.

## Circuit Diagram



Circuit Diagram

## Marking Diagram

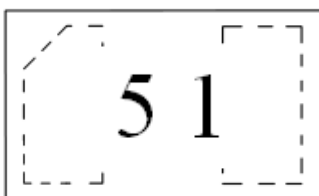

**Transparent top view**

51: Device Marking Code

## Features

- \* Ultra small package: 1.0x0.6x0.5mm
- \* Protects one data or power line
- \* Ultra low leakage: nA level
- \* Operating voltage: 5V
- \* Low clamping voltage
- \* 2-pin leadless package
- \* Complies with following standards:
  - IEC 61000-4-2 (ESD) immunity test
    - Air discharge:  $\pm 30\text{kV}$
    - Contact discharge:  $\pm 30\text{kV}$
  - IEC61000-4-5 (Lightning) 22A (8/20 $\mu\text{s}$ )
- \* RoHS Compliant

## Applications

- \* Cellular Handsets and Accessories
- \* Personal Digital Assistants
- \* Notebooks and Handhelds
- \* Portable Instrumentation
- \* Digital Cameras
- \* Power Lines
- \* Tablets

## Ordering Information

Part Number	Packaging	Reel Size
JLS05UGD2-2	10000/Tape & Reel	7 inch



## JLS05UGD2-2

### Absolute Maximum Ratings ( $T_A=25^\circ\text{C}$ unless otherwise specified)

Parameter	Symbol	Value	Unit
Peak Pulse Power (8/20 $\mu\text{s}$ )	Ppk	250	W
Peak Pulse Current (8/20 $\mu\text{s}$ )	IPP	22	A
ESD per IEC 61000-4-2 (Air)	VESD	$\pm 30$	kV
ESD per IEC 61000-4-2 (Contact)		$\pm 30$	
Operating Temperature Range	TJ	-55 to +125	$^\circ\text{C}$
Storage Temperature Range	Tstg	-55 to +150	$^\circ\text{C}$

### Electrical Characteristics ( $T_A=25^\circ\text{C}$ unless otherwise specified)

Parameter	Symbol	Test Condition	Min	Typ	Max	Unit
Reverse Working Voltage	$V_{RWM}$				5.0	V
Breakdown Voltage	$V_{BR}$	$I_T = 1\text{mA}$	6.0	7.0	8.0	V
Reverse Leakage Current	$I_R$	$V_{RWM} = 5.0\text{V}$			5	$\mu\text{A}$
Clamping Voltage	$V_C$	$I_{PP} = 1\text{A}$ (8 x 20 $\mu\text{s}$ pulse)			8.0	V
Clamping Voltage	$V_C$	$I_{PP} = 22\text{A}$ (8 x 20 $\mu\text{s}$ pulse)			12.0	V
Junction Capacitance	$C_J$	$V_R = 0\text{V}$ , $f = 1\text{MHz}$		150	180	pF

### Portion Electronics Parameter

Symbol	Parameter
$I_T$	Test Current
$I_{PP}$	Maximum Reverse Peak Pulse Current
$V_C$	Clamping Voltage @ $I_C$

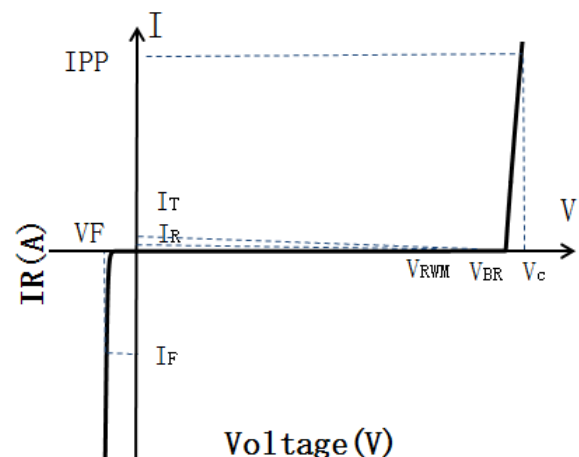



# JLS05UGD2-2

## Typical Performance Characteristics ( $T_A=25^{\circ}\text{C}$ unless otherwise Specified)

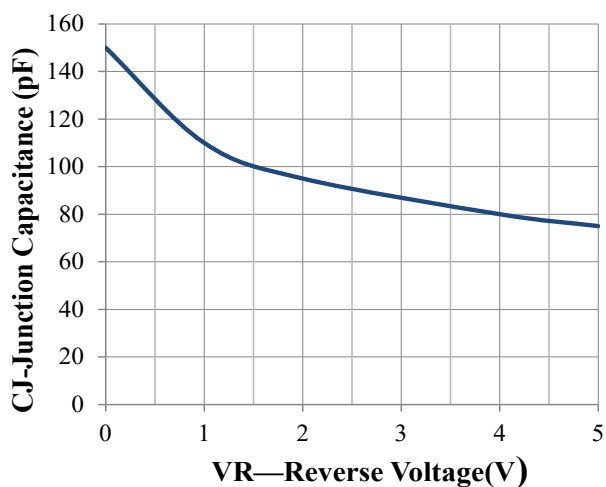

Junction Capacitance vs. Reverse Voltage

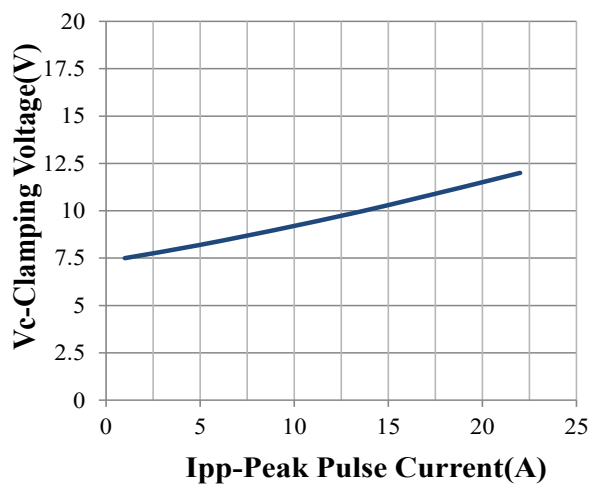

Clamping Voltage vs. Peak Pulse Current

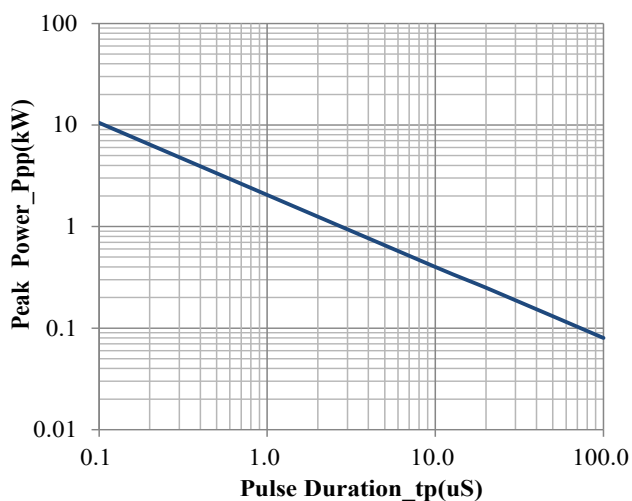

Peak Pulse Power vs. Pulse Time

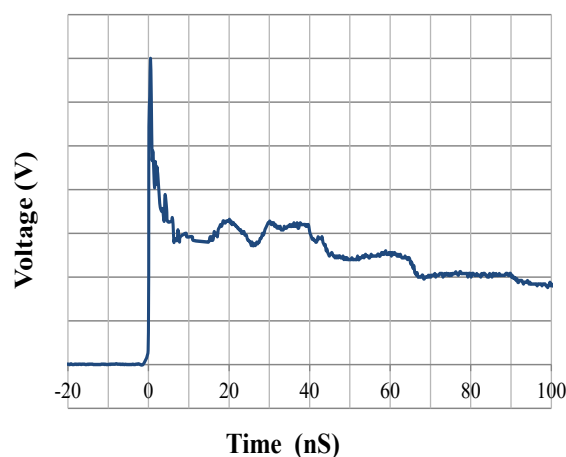

IEC61000-4-2 Pulse Waveform

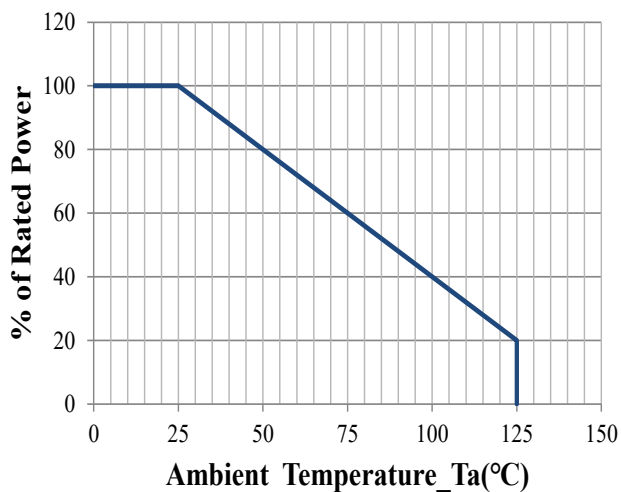

Power Derating Curve

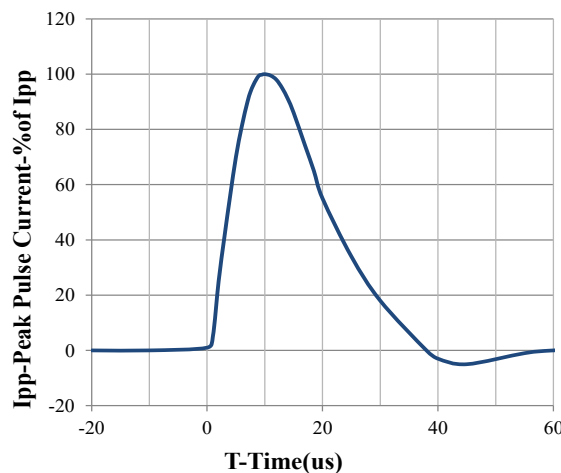

8 X 20us Pulse Waveform



## DFN1006-2 Package Outline Drawing

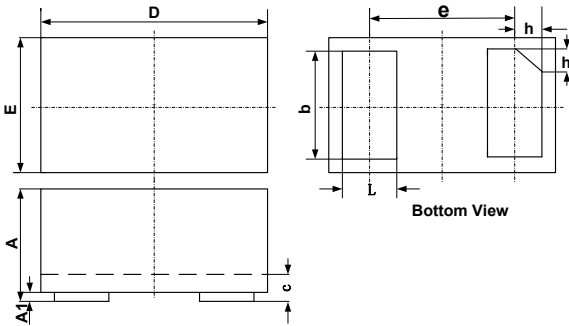

SYM	DIMENSIONS					
	MILLIMETERS			INCHES		
	MIN	NOM	MAX	MIN	NOM	MAX
A	0.45	0.50	0.55	0.018	0.020	0.022
A1	0.00	0.02	0.05	0.000	0.001	0.002
b	0.45	0.50	0.55	0.018	0.020	0.022
c	0.12	0.15	0.18	0.005	0.006	0.007
D	0.95	1.00	1.05	0.037	0.039	0.041
e	0.65 BSC			0.026 BSC		
E	0.55	0.60	0.65	0.022	0.024	0.026
L	0.20	0.25	0.30	0.008	0.010	0.012
h	0.07	0.12	0.17	0.003	0.005	0.007

## Suggested Land Pattern

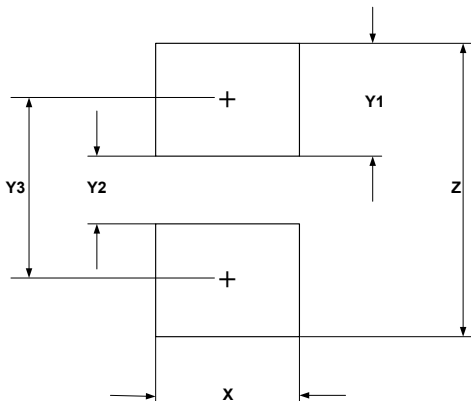

SYM	DIMENSIONS	
	MILLIMETERS	INCHES
X	0.60	0.024
Y1	0.50	0.020
Y2	0.30	0.012
Y3	0.80	0.032
Z	1.30	0.052

## NOTICE

Jelan-Link reserves the right to make changes without further notice to any products here in.

Only obligations are those in the Jelan-Link Standard Terms and Conditions of Sale and in no case will Jelan-Link be liable for any incidental, indirect, or consequential damages arising from the sale, resale, use, or misuse of its products.